

Roller Massager

VS21-CER-H (Built-in Heater)

VS21-CER

INSTRUCTION MANUAL

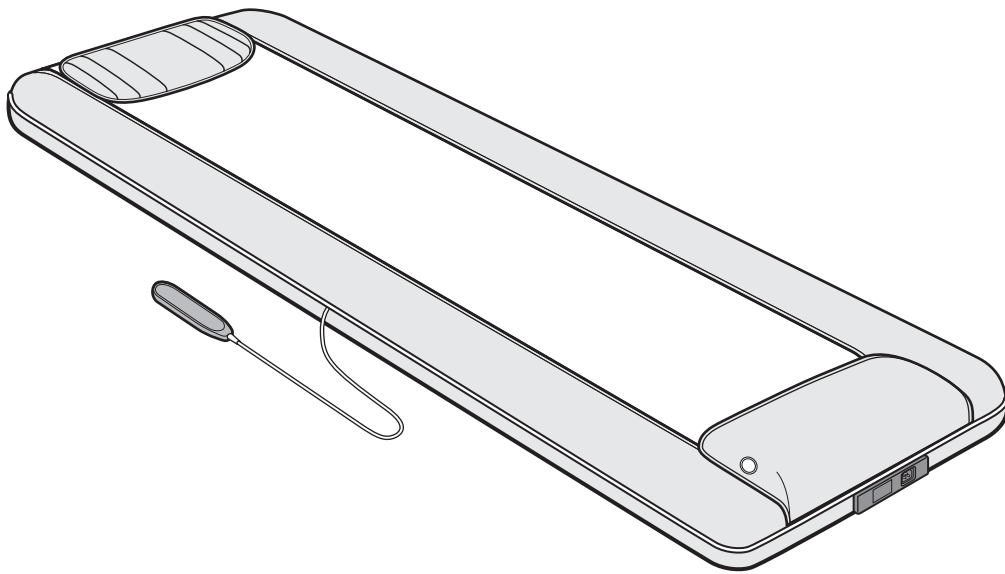







CONTENTS

For Safety	1
Components of the Massager	5
Using the Massager	6
Having a Massage	7
Thermal Therapy	11
After Using the Massager	12
Storing the Massager	13
Maintaining the Massager	13
Features and Effects	14
Rating and Specifications	14
Troubleshooting	15

- Thank you for purchasing the Massager.
- Read the instruction manual carefully to ensure safe, proper use of your massager.
- Save this manual for later reference as needed.

For Safety

This instruction manual and product use the following symbols to ensure proper, safe use of the product and to prevent possible injury to users and damage to property. Be sure you understand what each symbol means before reading each instruction.

Classification	 WARNING	Failure to heed the warning may result in death or serious injury.
	 CAUTION	Failure to heed the warning may result in personal injury or property damage.
Examples of symbols		The  symbol indicates a prohibited act. (In the example, do not disassemble the component.)
		The  symbol indicates a required procedure. (In the example, you must unplug the massager from the outlet.)

WARNING

To prevent accidents or deterioration in physical condition, consult a physician in the event of any of the following:

- You are receiving medical treatment or feel that you are in poor physical condition;
- You use a heart pacemaker or any other implanted electrical medical device susceptible to electromagnetic interference;
- You have a malignant tumor;
- You have a heart disorder;
- You have a thermal-sense disorder;
- You have suffered a low-temperature burn;
- You are menstruating, in the early stages of pregnancy, or you delivered a baby recently;
- You have a perceptive disorder caused by a high-level peripheral circulation disorder due to diabetes;
- You have wounds on the skin;
- You are required to lie quietly in bed;
- You have a fever higher than 38°C;
- You have osteoporosis, a broken backbone, sprains, a pulled muscle, or any other acute disorder (sharp pain);
- You have a back disorder or scoliosis; or
- You want to use the massager on an area that has been treated medically in the past or an area with problems.



Consult a physician

If you are concerned or anxious about using the massager for a reason not listed above, consult a specialist before using the massager. If using the massager has no effect, then consult a physician as well.





If you experience any abnormal physical condition during or after use of the massager, stop immediately and consult a physician to prevent accidents or adversely affecting your health.

Before using the massager, ensure that the surface material of the main unit and the other components have no tears. If a tear is found, then stop immediately and unplug the massager to prevent accidents, injury, or electric shock.



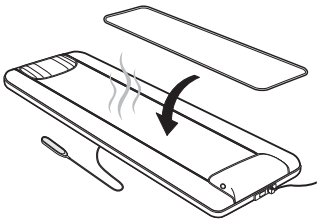

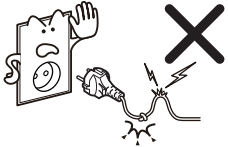
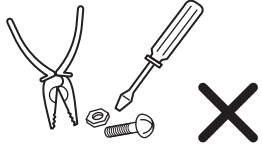
Inspect before use





⚠ WARNING

<p>When using the heater, the precautions below must be followed. Otherwise, low-temperature burns may result.</p> <ul style="list-style-type: none"> ● Do not use the massager after ingesting sleep medication or alcohol. ● The appliance has a heated surface. Persons insensitive to heat must be careful when using the appliance. ● Always use a pad or blanket before starting the massager. ● If the massager is too hot, immediately turn off the heater. ● Do not use the massager continuously for longer than 15 minutes. 	  <p>Be careful to avoid low-temperature burns.</p>
<p>Do not use the massager against a physician's advice. Doing so may cause one to feel ill.</p>	
<p>This appliance can be used by children aged from 8 years and above and persons with reduced physical, sensory or mental capabilities or lack of experience and knowledge if they have been given supervision or instruction concerning use of the appliance in a safe way and understand the hazards involved.</p> <p>Children shall not play with the appliance to prevent accidents or personal injury.</p> <p>Cleaning and user maintenance shall not be made by children without supervision.</p>	
<p>Do not allow a child to use the massager alone or to play on the main unit to prevent accidents and possible injury.</p>	 <p>Do not</p>
<p>The massager must be powered only with 220-240VAC 50-60 Hz to prevent fire or electric shock.</p>	
<p>If the power cord or plug is damaged or the plug is not securely inserted into an outlet, do not use the massager to prevent electric shock, short circuits, or fire.</p>	
<p>The cords, including the power cord, must not be damaged, broken, modified, or forcibly bent, pulled, twisted, bound, or placed near heat sources. In addition, do not pinch or place heavy objects on the cords to prevent fire or electric shock.</p>	
<p>Do not disassemble, repair, or modify the product to prevent fire, electric shock, or personal injury.</p>	  <p>Do not disassemble</p>



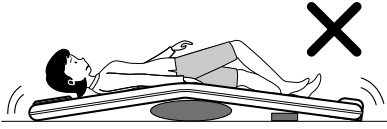

⚠ CAUTION

<p>Before using the massager, ensure that it works properly. If you use the massager when it has not been used for some time, be sure that it operates properly and safely to prevent accidents.</p>	 <p>Inspect before use</p>
<p>Do not use the massager longer than 15 minutes at one time. Use the massager according to your physical condition (one or two times a day) to prevent muscles, skin, or the nervous system from being excessively stimulated.</p>	 <p>Caution</p>

⚠ CAUTION

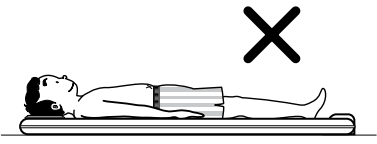
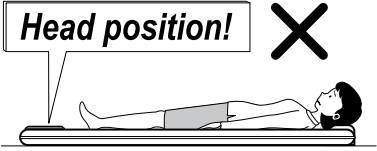
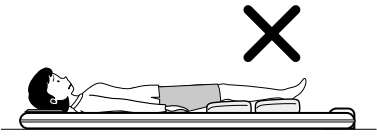
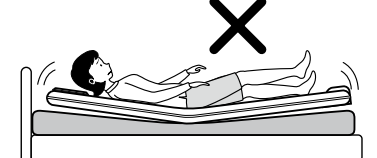
<p>Prior to becoming accustomed to the massager or if the massage is too strong, use a pad or blanket. If this does not eliminate the (acute) discomfort, stop using the massager to prevent accidents or adversely affecting your health.</p>	
<p>The massager must be used at a horizontal location without projections or obstructions to prevent accidents, failure, or damage to the massager.</p>	 <p style="text-align: right;">⚠ Caution</p>
<p>Fully insert the power plug into the outlet to prevent electric shock, short circuits, or fire.</p>	
<p>When unplugging the massager, hold the power plug instead of the cord to prevent electric shock, short circuits, or fire.</p>	 <p style="text-align: right;">⚠ Handle the plug carefully</p>
<p>When the massager is not in use, unplug it to prevent accidents, fire due to current leakage, or electric shock due to poor insulation.</p>	
<p>During a power outage, immediately unplug the massager to prevent hazards when the power is restored.</p>	
<p>In the event of any malfunction, immediately stop using the massager and unplug it to prevent electric shock or fire due to current leakage or a short circuit.</p>	 <p style="text-align: right;">Unplug the massager</p>
<p>When maintaining the massager, be sure that it is unplugged. Do not disconnect the plug with wet hands to prevent electric shock or personal injury.</p>	
<p>Do not use a different medical device in combination with the massager to prevent accidents and injuries.</p>	
<p>Do not use heating appliances, such as an electric blanket or carpet, in combination with the massager to prevent failure and damage to the massager.</p>	
<p>Use the massager for therapeutic purposes only to prevent malfunctions and accidents.</p>	
<p>The massager must not be used by more than one person at one time. Do not sit or stand on the massager or lie on your stomach on the massager during use. Use the massager with one person in the correct posture to prevent accidents, failure, or damage to the massager.</p>	 <p style="text-align: right;">Do not</p>
<p>Do not use the massager after drinking or within 30 minutes after a meal to prevent accidents or adversely affecting your health.</p>	
<p>Do not sleep while using the massager to prevent accidents or personal injury.</p>	

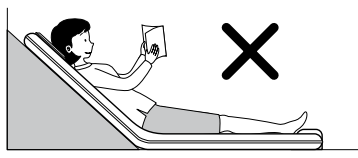
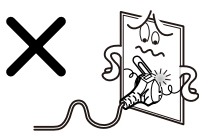
⚠ CAUTION

<p>Do not use the massager when the skin is wet; doing so may result in possible damage to your skin, electric shock, or failure of the massager.</p>		
<p>Do not reverse your body orientation; the head must be placed at the headrest and the feet at the inlet to prevent accidents.</p>		
<p>Do not start the rollers with the weights under your body or legs. When not using the massager, do not start the rollers with the weights on to prevent failure and damage to the massager.</p>		
<p>Do not use the massager on a mattress or any other soft material to prevent accidents, failure, or damage to the massager.</p>		 Do not
<p>Do not bend or angle the main unit to prevent accidents, failure, or damage to the massager.</p>		
<p>Do not ride on or place heavy objects on the massager when it is folded. Doing so may cause failure or damage to the massager.</p>		
<p>Do not drop, step on, or pull the remote control. Do not operate the unit with wet hands to prevent electric shock, failure, or damage to the massager.</p>		
<p>Do not allow metal, dust, or moisture to adhere to the plugs to prevent electric shock, short circuits, or fire.</p>		
<p>When the rollers are moving, do not disconnect the power or connector plug to prevent accidents, failure, or damage to the massager.</p>		
<p>Do not use the massager in the bathroom or any other wet location to prevent electric shock and failure of the massager.</p>		 Do not use in the bathroom or other wet locations
<p>Do not expose the main unit or remote control to water to prevent electric shock and failure of the remote control.</p>		 Do not expose to moisture

Components of the Massager

Main unit

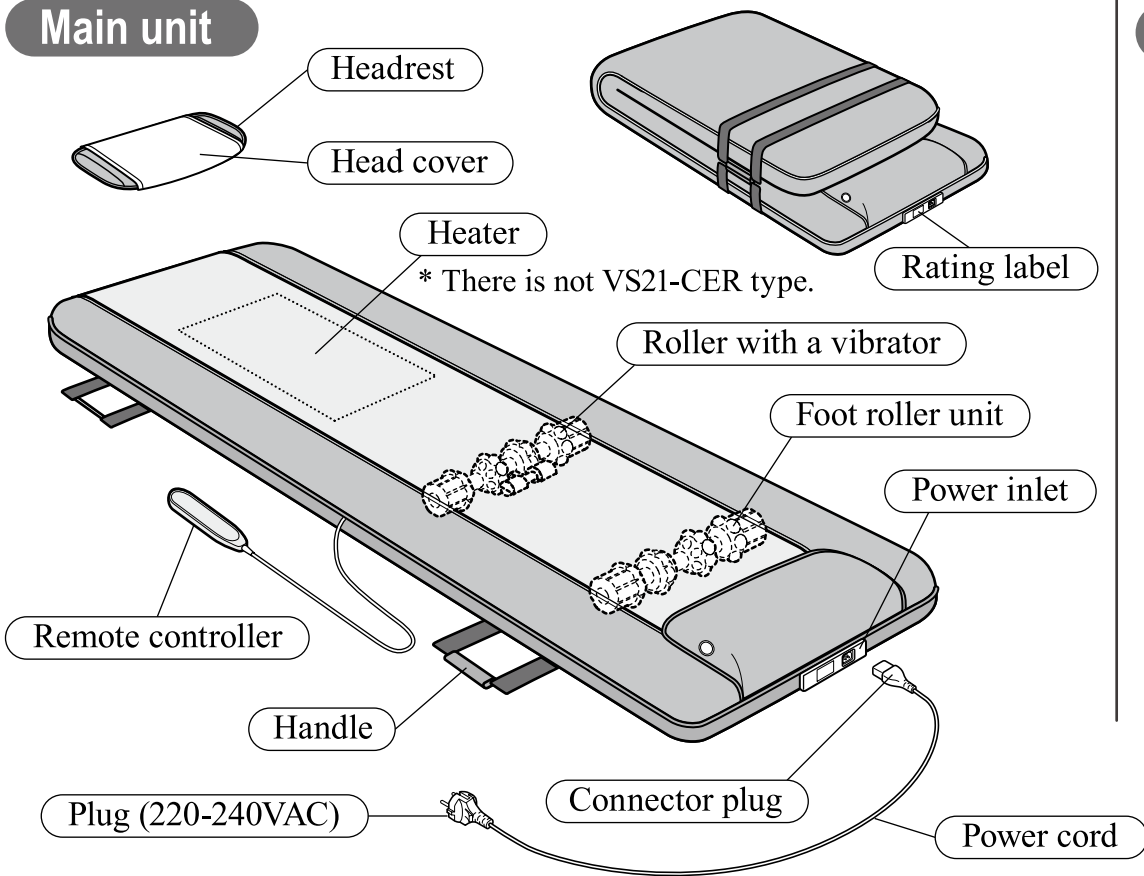

Accessories

Weights (2 units)

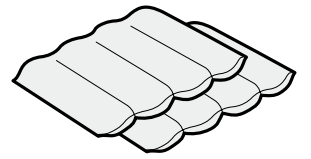

Pad

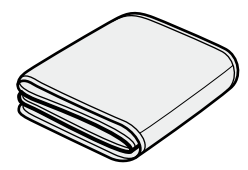

Remote control

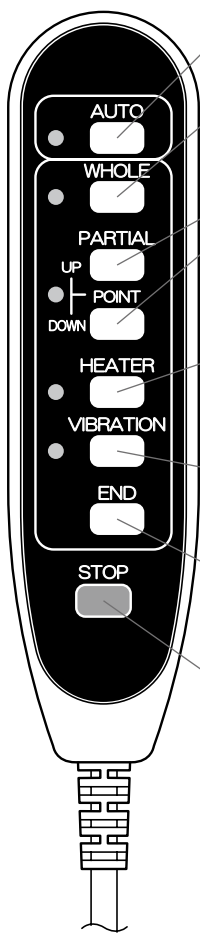

- AUTO**
Select from among three automatic modes: Whole, Upper, and Lower.
- WHOLE**
Have a whole-body massage or partial massages at up to three areas of the body.
- PARTIAL**
Have a partial massage in the desired area. Move the rollers using the UP or DOWN button. Pressing both buttons at the same time stops the rollers, providing a point massage.
- HEATER** * There is not VS21-CER type.
Use this button to turn the heater on and off. Select thermotherapy mode (the lamp blinks) to use only the heater. During a massage, thermal mode (the lamp stays illuminated) is active.
- VIBRATION**
Select between two types of vibration actions: Easing and Beating. If automatic mode is active, the vibration action cannot be changed.
- END**
Use this button to discontinue the therapy. The action remains stopped while the button is pressed.
- STOP**
Use this button to immediately stop the action during a massage (all the lamps start blinking). Note that the safe stop function will not be cancelled until the END button is pressed.

Using the Massager

* Before using the massager, read the Safety section to ensure proper use.

1. Unfolding the Main Unit

- (1) Unlock both handles. Then, unfold the main unit on a clean, flat surface.
- (2) Insert the connector plug into the inlet and the power plug into an outlet.
(If the rollers are not located at the foot position, they will move to that position.)
- (3) Before using the massager, ensure that there are no tears on the surface material where the rollers pass under and that the massager operates properly.

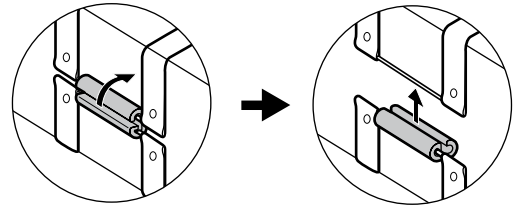

2. Lying on Your Back on the Main Unit

- (1) Attach the head cover to the headrest. Then, place the pad and headrest on the main unit.
- (2) When using the heater, prior to becoming accustomed to the main unit, or if the massage is too strong, spread the pad or blanket over the main unit.
- (3) With your head positioned about 3 cm from the top of the massager, relax your body and lie comfortably in the center of the main unit.
- (4) Place the weights on your knees and feet to enhance the effect of the massage on your lower-body.

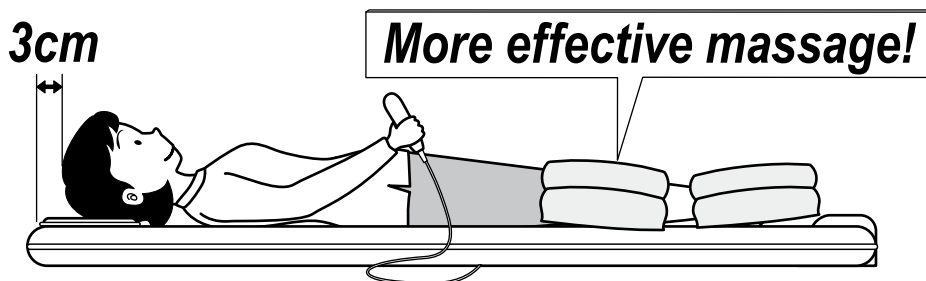

3. Using the Remote Control

- (1) Select the desired massage mode by referring to “Having a Massage” and “Thermal Therapy.” Do not use the remote control until resting on the massager.
- (2) Change the massage mode and action by pressing the appropriate buttons.

4. Ending the Massage

- (1) After 15 minutes, the massager automatically starts the termination process and returns to standby status.
- (2) Press the END button to discontinue the massage at any time. The massager starts the termination process.

Having a Massage

Automatic Massage

Each automatic massage mode uses a combination of whole-body and partial reciprocating motions of the rollers and vibrations. Press the AUTO button and select from among three types of automatic massage modes: Whole, Upper, and Lower.

* Each automatic massage mode is programmed to automatically turn on the heater and vibrator. If heating is not needed, use the Heater button to turn it off. Note that you cannot manually change the vibration action.

Auto Mode Whole-body Massage

Pressing the AUTO button once provides a programmed whole-body massage from the neck to the ankles. The AUTO lamp stays illuminated.

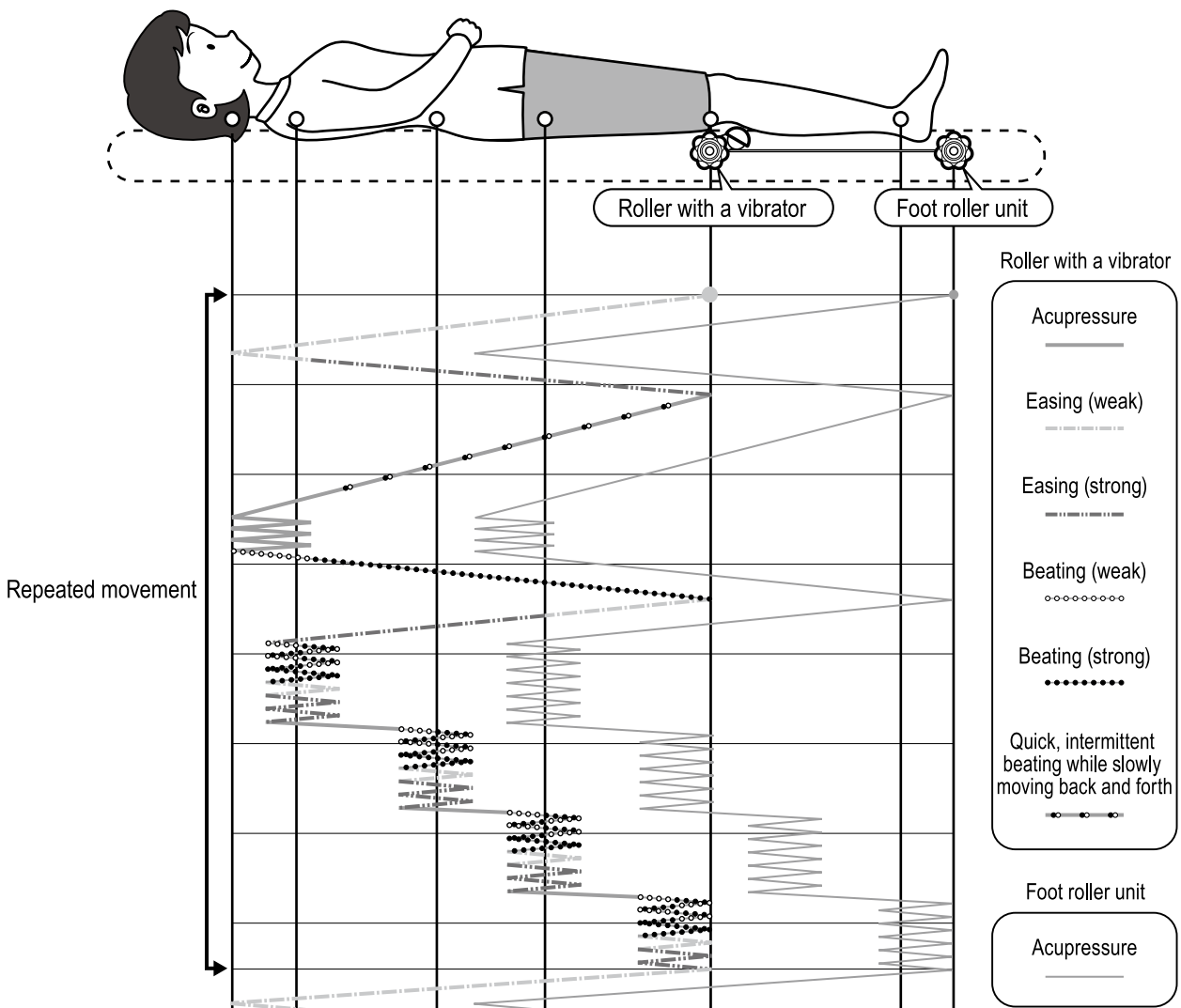
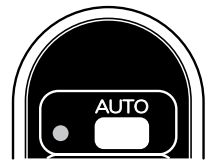

Upper-body Massage

Pressing the AUTO button twice provides a programmed massage from the neck to the knees. The AUTO lamp blinks every second.

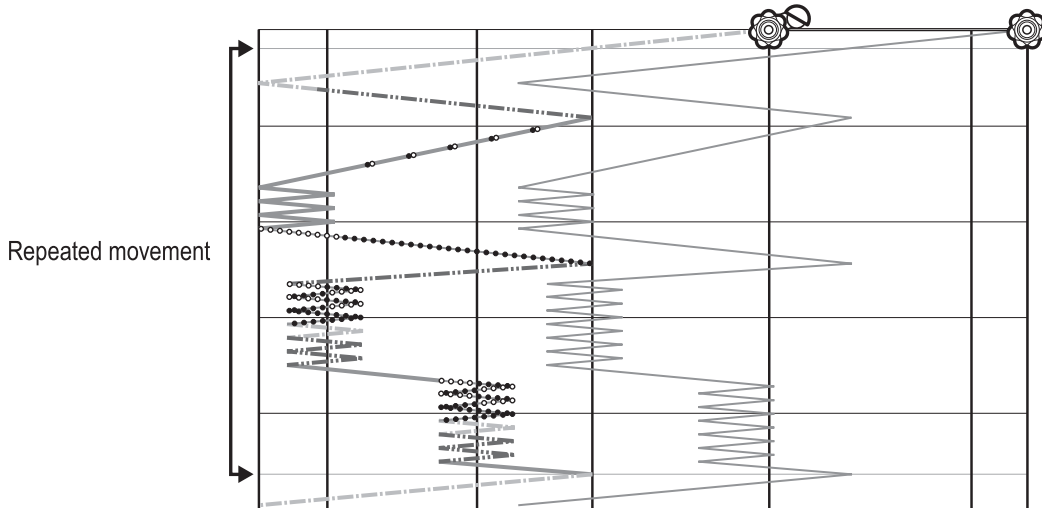

Lower-body Massage

Pressing the AUTO button three times in a row within two seconds or pressing the AUTO button for 2 seconds or longer provides a programmed massage from the lower back to the ankles. The AUTO lamp blinks twice a second.

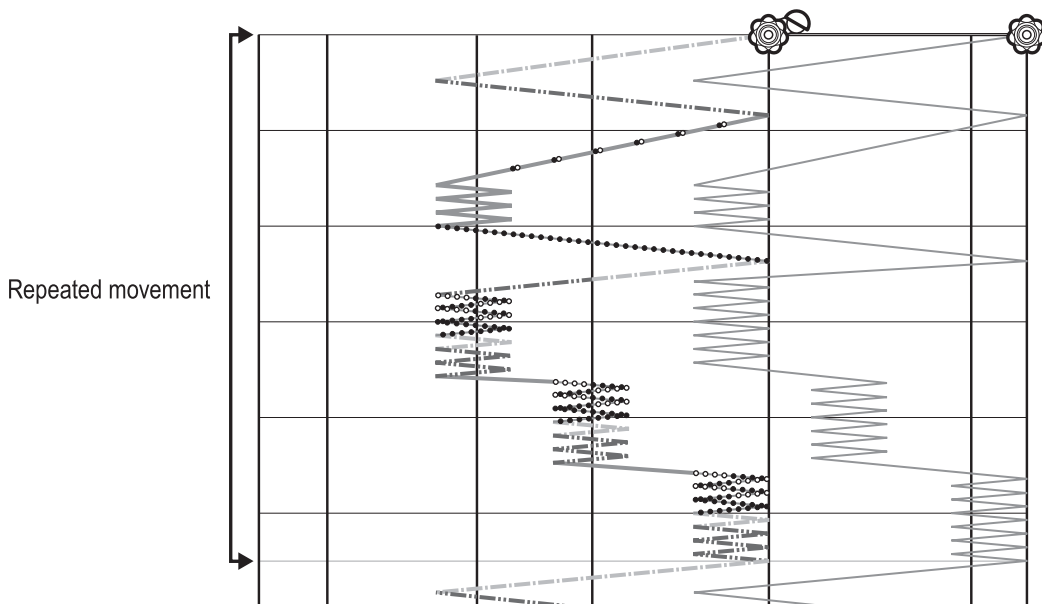

Manual Massage

Have the desired massage by combining two types of vibrations (easing and beating) and three types of massages (whole body, partial, and point).

Vibrations

Each press of the VIBRATION button switches the vibration type as follows:

Easing → Beating → Halt → Easing → Beating → ...

The lamp indicates the type of vibration (the lamp remains on for easing or blinks for beating).

* You cannot manually change the vibration mode. In manual mode, the vibration is always in Strong mode.



When the vibration feature is active, resonance may occur, producing a temporary loud vibration sound. This is caused by the structure of the massager and is not a malfunction.

Continuous use of vibration around the neck may result in discomfort. Exercise additional care when using the vibrator.

Whole-body Massage

Pressing the WHOLE button once provides a whole-body massage where the rollers make the reciprocating motion between the neck and ankles. (the WHOLE lamp stays illuminated).

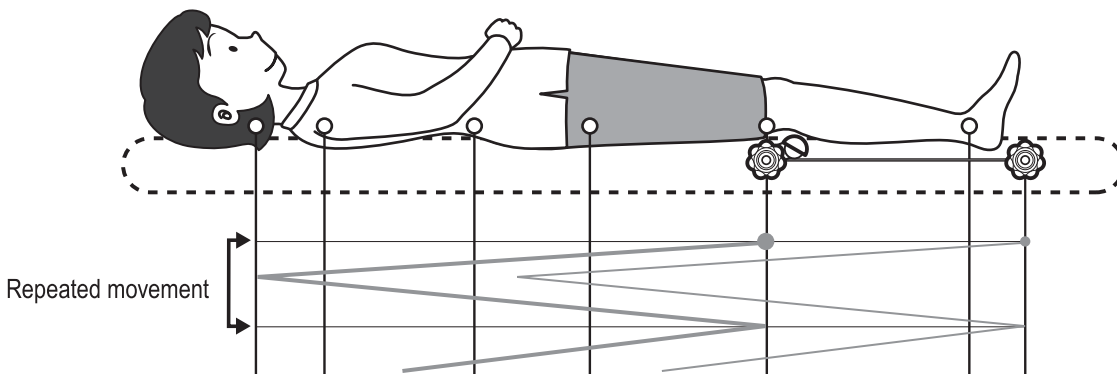

For an intensive massage in a certain area during a whole-body massage, press the WHOLE button when the rollers reach the appropriate area. The rollers will make three reciprocating motions with a stroke of about 12 cm in that area, and then will resume the whole-body massage (The WHOLE lamp starts blinking again).

Each area specified by you is memorized by the built-in microprocessor. Each time the rollers come to the appropriate position during a whole-body massage, they will provide a partial massage.

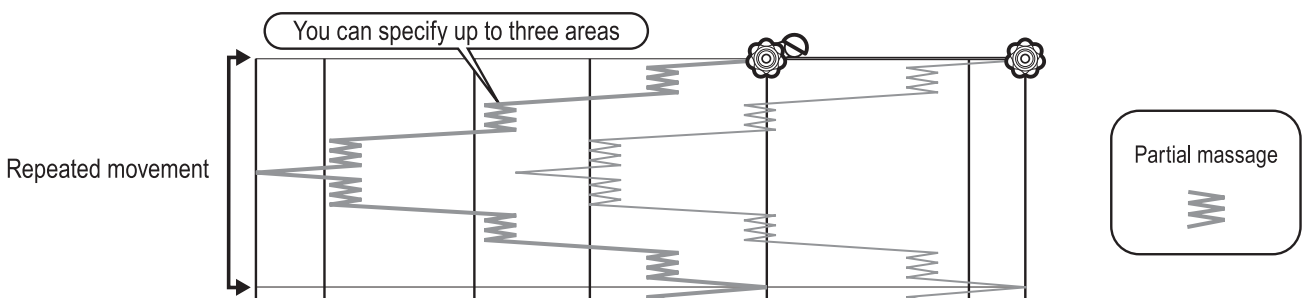

Number of areas memorized The massager can memorize up to three areas. If you specify a fourth area, the oldest area is erased from memory.

* When having a partial massage in a specified area, you cannot specify a different area.

To cancel the specified areas Press any of the AUTO, UP/DOWN for PARTIAL, and END buttons, and then the WHOLE button. The memorized areas are cancelled, and the rollers will only make the reciprocating motion between the neck and the ankles.

Partial Massage

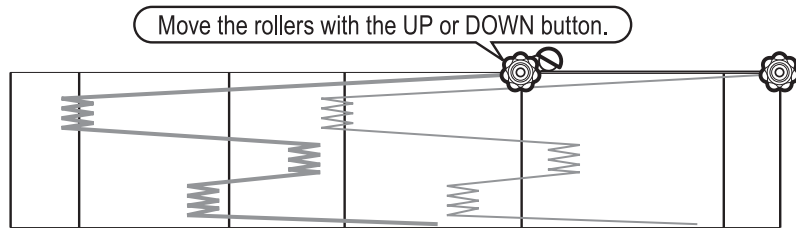

Press and release the UP or DOWN button for PARTIAL to select a partial massage and reciprocating motion in that area with a stroke of 12 cm (the PARTIAL lamp stays illuminated). When the UP button for PARTIAL is pressed and held, the rollers keep moving toward the head. When the button is released, the rollers then start a partial massage in that position. To move the rollers toward the feet, press the DOWN button.

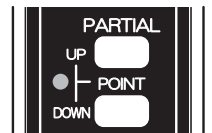

* If you press the UP button for PARTIAL and immediately release it when the rollers are located at the foot end position or if you press the DOWN button for PARTIAL and immediately release it when the rollers are located at the head end position, then the rollers stop for a moment. This is caused by the program and is not a malfunction.

Point Massage

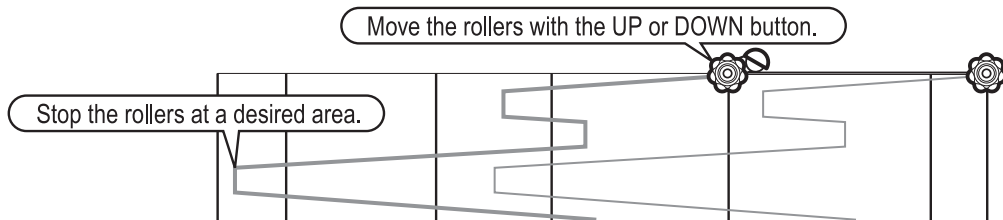

Pressing the UP and DOWN button for PARTIAL at the same time stops the movement of the rollers, providing a point massage (the PARTIAL lamp blinks). To move the rollers toward the head, press and hold the UP button. To move the rollers toward the feet, press and hold the DOWN button.

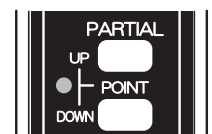

* If the heater is used during a point massage, it is automatically placed in Thermal mode when the vibrator is in action or in Thermal Therapy mode when the vibrator is not in action.

1. Pressing the HEATER Button

When a massage is not being given, press the HEATER button. The HEATER lamp starts blinking for the start of thermal therapy.



* If you press any of the massage buttons during thermal therapy, the heater automatically switches to Thermal mode (the HEATER lamp stays illuminated).

WARNING

Follow the precautions below when using the heater to avoid low-temperature burns.

- Do not use the heater after ingesting sleep medications or alcohol.
- Always supervise a child or someone insensitive to heat when using the heater.
- Use a pad or blanket before turning on the heater.
- If it is too hot, immediately turn off the heater.
- Do not use the heater continuously for longer than 15 minutes.



Be careful
to avoid
low-temperature
burns

While the skin can normally be burned by contact with a hot material, a relatively low temperature of 40°C to 60°C may cause a low-temperature burn if the skin remains in contact with the heat source for a long time. Extra attention should be paid when using the heater.

After Using the Massager

1. Put Away the Cords and Fold the Main Unit

- (1) Disconnect the power and connector plug. The power cord must be put away so that it will not be lost.
* In standby mode, the massager consumes a small amount of electrical power even when it is not operating.
- (2) Slowly fold the main unit with the headrest upward. The remote control must be placed inside the folded main unit.
- (3) Hook the handle to lock the main unit.

CAUTION

When the rollers are located around the bending portion, do not fold the main unit. When the STOP button has been pressed, be particularly careful not to do so to prevent possible failure and damage to the massager.

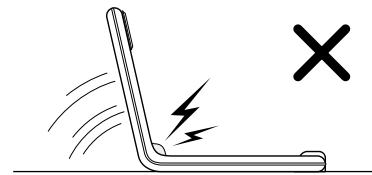

Do not

The massager must be folded inward, not outward to prevent failure or damage.

2. Carrying the Massager

Ensure that the handles are locked before carrying the massager.

CAUTION

The massager must be carried with the remote control inside the main unit, both handles locked, and the base portion of the remote control cord upward to prevent failure and damage.



Be careful when handling

Do not drop, strike, or roughly handle the main unit to prevent damage to the floor and failure and damage to the massager.



Do not

Storing the Massager

The precautions below must be followed for proper storage of the massager.

CAUTION

The massager must not be stored upright; doing so may result in failure or damage if the unit should fall.

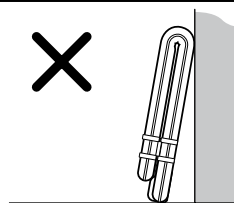

Do not place heavy objects on the massager to prevent failure and damage.



Do not

To prevent accidents, damage, failure, cracking, deformation, and discoloration, the massager must not be exposed to the following:

- Direct exposure to high temperatures produced by heat sources;
- Exposure to direct sunlight for long periods of time;
- Exposure to vibration or shock; or
- Exposure to water or moisture.

Maintaining the Massager

The precautions below must be followed to properly maintain the massager.

● **Periodic Maintenance**

Dry the main unit and pad in the shade approximately every two weeks in a well-ventilated location away from exposure to direct sunlight.

● **Maintaining the surface material**

After dusting the surface material, use a cloth soaked in a neutral detergent diluted with water, then squeezed tightly, to remove stains by tapping the cloth on the material.

● **Maintaining the Remote Control**

Use a dry cloth to wipe stains. Never use a damp cloth because it may cause a malfunction.

● **Maintaining the Head Cover**

When soiled, clean up the head cover by wash machine (40°C) or dry cleaning (petroleum), no bleaching and no high temperature iron.

CAUTION

Never use thinner, benzine, alcohol, or other solvents or polishing powders to wipe stains; doing so may result in discoloration and damage to the massager.



Do not

Notice for WEEE directive

In accordance with the WEEE directive, whenever this product is sold in member states of the EU it must mandatorily bear the WEEE mark. When disposing of this product in an EU member state, do so in accordance with the law of that state.



Features and Effects

Features

1. Automatic Programmed Massages Available

- The roller with a vibrator and foot roller provide programmed Shiatsu(acupressure) massages to the whole body from the neck to the ankles along the spine.
- The massager offers three types of programmed massages (Whole, Upper and Lower) and Whole-body, partial and point massages.
- The rollers, vibrator, and heater can be used in combination, significantly enhancing effectiveness.

2. Vibration Feature

- The roller with a vibrator offers massages with two types of vibrations (easing and beating) from the neck to the knees.

3. Built-in Heater (* There is not VS21-CER type.)

- The built-in heater offers thermal therapy to your upper and lower back if desired.

4. Overuse Prevention Timer

- The timer automatically terminates the massage for safety after 15 minutes.

5. Safety Stop to Prevent Danger

- Pressing the STOP button immediately stops the action in an emergency.

6. Easy-to-carry Folding Main Unit

- The main unit folds, fitting in almost anywhere. In addition, it is easy to carry because of the lightweight design.

Effects

As substitutes for acupressure and massage

- Recovering from fatigue
- Easing muscle stiffness
- Refreshing fatigued muscles
- Improving blood circulation
- Easing nerve and muscular pain

Heating Effects (* There is not VS21-CER type.)

- Recovering from fatigue
- Easing muscle stiffness
- Refreshing fatigued muscles
- Improving blood circulation
- Easing nerve and muscular pain
- Improving the workings of the stomach and intestines

Rating and Specifications

Type : Roller Massager VS21-CER-H
Rating : 220-240 VAC, 50-60 Hz, 0.48A
Dimensions of the Main Unit : 62 (W) x 208 (L) x 9 cm (H) (Motor: 12 cm)
Dimensions the Main Unit When Folded : 62 (W) x 110 (L) x 18 cm (H)
Weight of the Main Unit : Approx. 15 kg.

Type : Roller Massager VS21-CER
Rating : 220-240 VAC, 50-60 Hz, 0.38A
Dimensions of the Main Unit : 62 (W) x 208 (L) x 9 cm (H) (Motor: 12 cm)
Dimensions the Main Unit When Folded : 62 (W) x 110 (L) x 18 cm (H)
Weight of the Main Unit : Approx. 15 kg.

Troubleshooting

* While using the massager, you may hear the following noises. They are caused by the structure of the product and do not indicate a malfunction.

Operating noises produced when the massager is in action.

- Motor gear noise
- Motor reversing noise
- Remote control beeper
- Vibrator resonance noise

* If any of the following symptoms appear, take the appropriate action shown below. If it does not correct the problem, then immediately stop using the massager and unplug it from the power source.

Symptom	Probable Cause and Remedy
1. The rollers make an unusual movement.	<ul style="list-style-type: none"> ▪ Check to see that the remote control cord is not damaged. ▪ If the remote control has been hit or dropped, then noise may cause a transitory malfunction. If this is the case, unplug and re-insert the plug for the massager. ▪ Check to see that you are properly operating the remote control. The roller movement may differ according to how you press each button.
2. The rollers are displaced.	<ul style="list-style-type: none"> ▪ Depending on the weight or build of the user, the rollers may be displaced from the position specified for partial/point acupressure. If this is the case, use the UP or DOWN button to relocate the rollers.
3. The rollers do not move. 4 The heater does not work.	<ul style="list-style-type: none"> ▪ Check to see that the power and connector plugs are securely inserted. ▪ If the massager has been used continuously, the temperature increase in the internal mechanism may activate the safety mechanism, automatically stopping the rollers. If this is the case, allow the massager to sit for a while, and then check whether the rollers or heater work. ▪ When unnecessary force is applied, the rollers may stop working for reasons of safety. If this is the case, reduce the load on the rollers by lifting your body a little. ▪ Check to see that the STOP button has not been pressed (if pressed, all lamps are blinking).
5. The rollers do not move with the WHOLE and VIBRATION lamps blinking.	<ul style="list-style-type: none"> ▪ A failure has been detected in the rollers with the vibrator. Immediately stop using the massager.
6. The power cord or plug is extremely hot. 7. The surface material where the rollers pass through is torn or damaged. 8. The power cord or plug is cracked or damaged. 9. The timer does not work. 10. The massager is broken.	<ul style="list-style-type: none"> ▪ Immediately stop using the massager.